

LEGENDA :

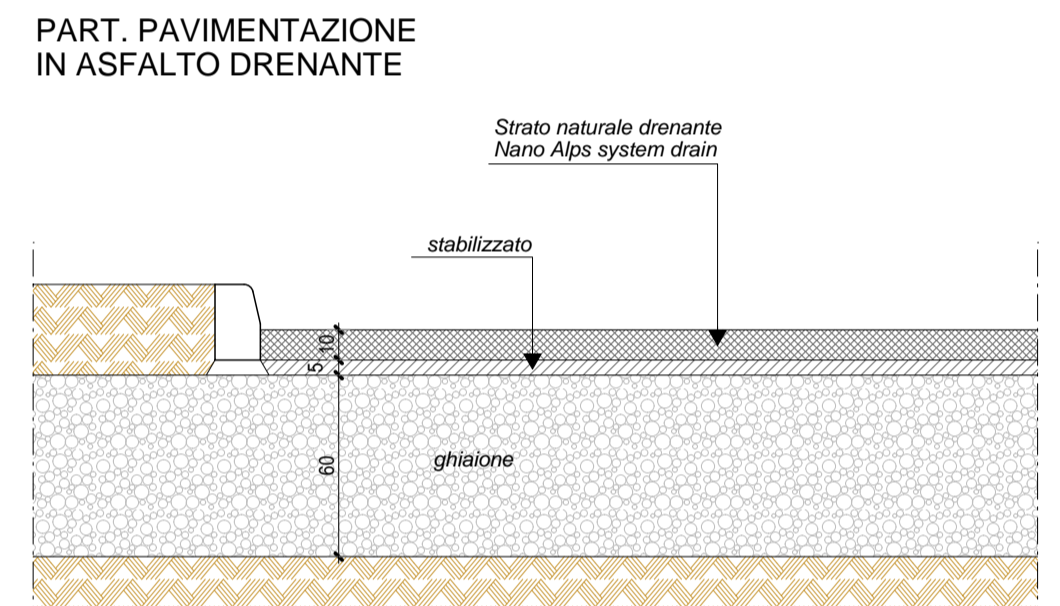

SCHEMA IMPIANTO TRATTAMENTO ACQUE DI PRIMA PIOGGIA

DISPOSIZIONE PLANIMETRICA scala 1:50

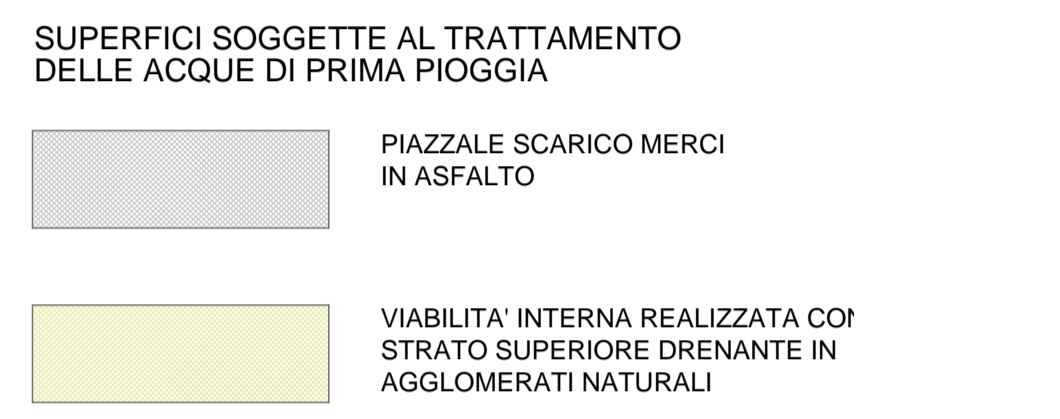
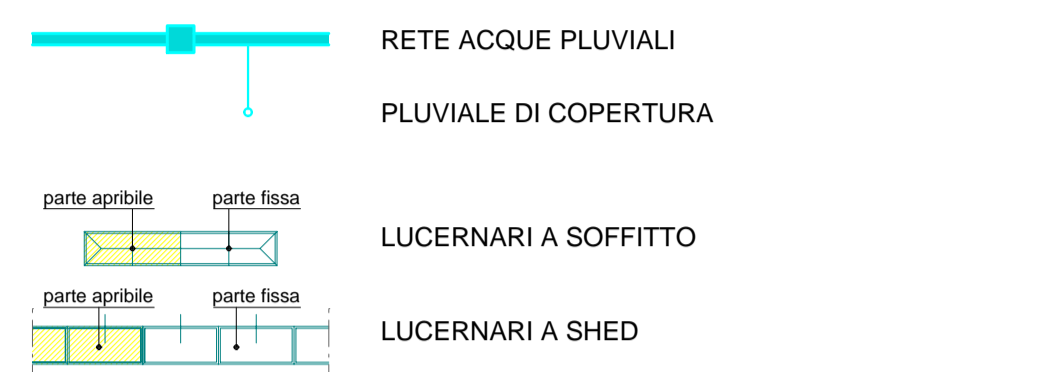
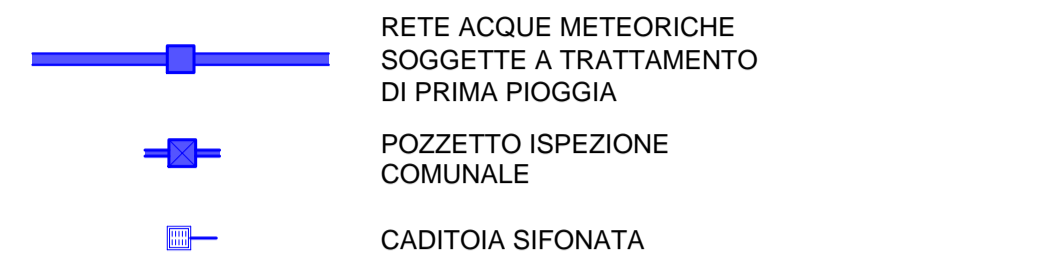
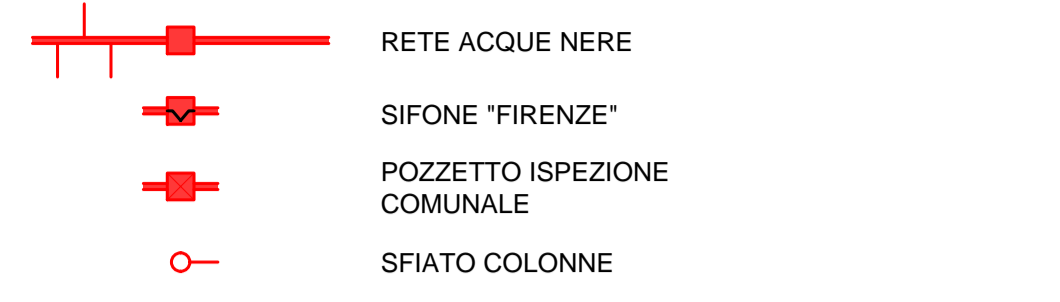
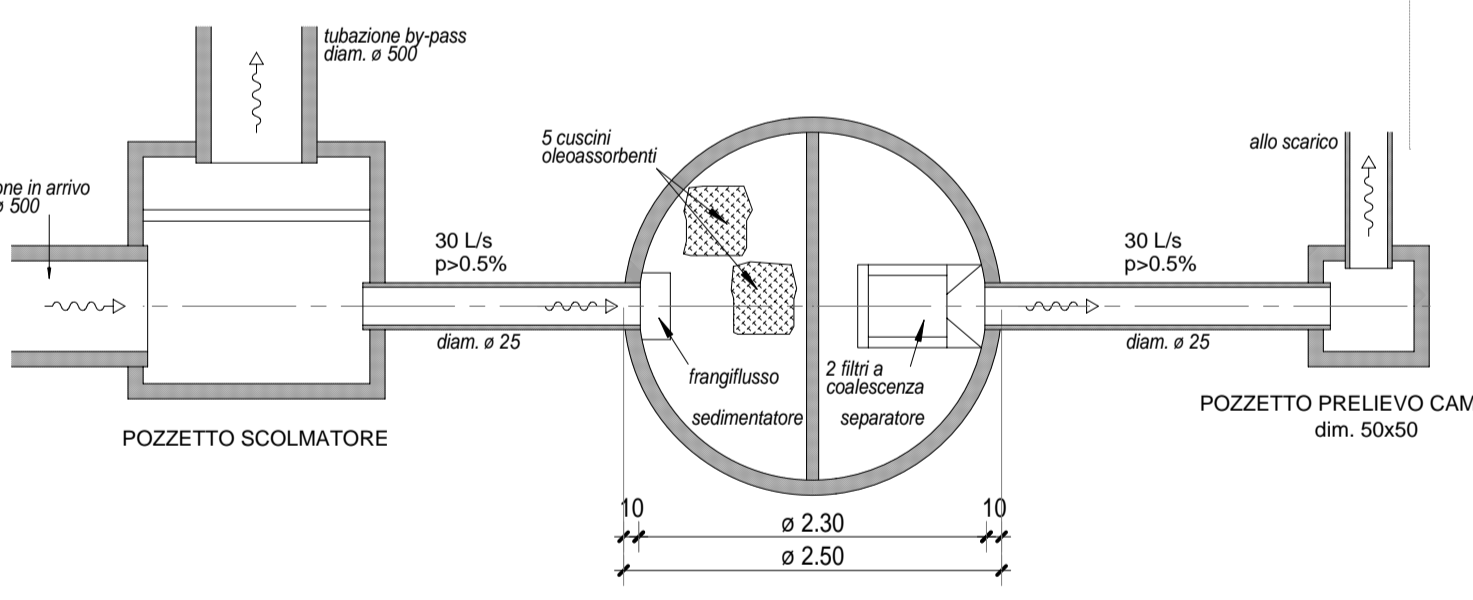

PROSPETTO SEZIONATO VASCHE scala 1:50

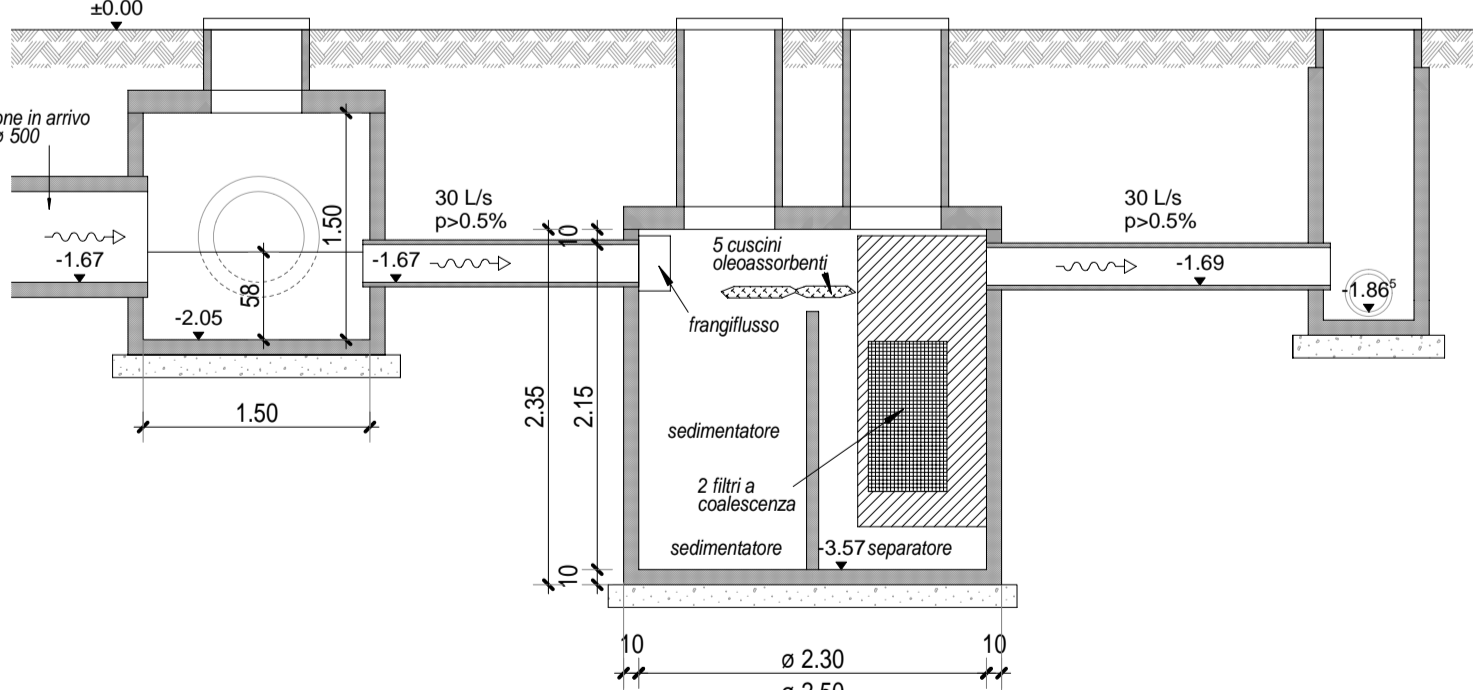

SCHEMA A BLOCCHI

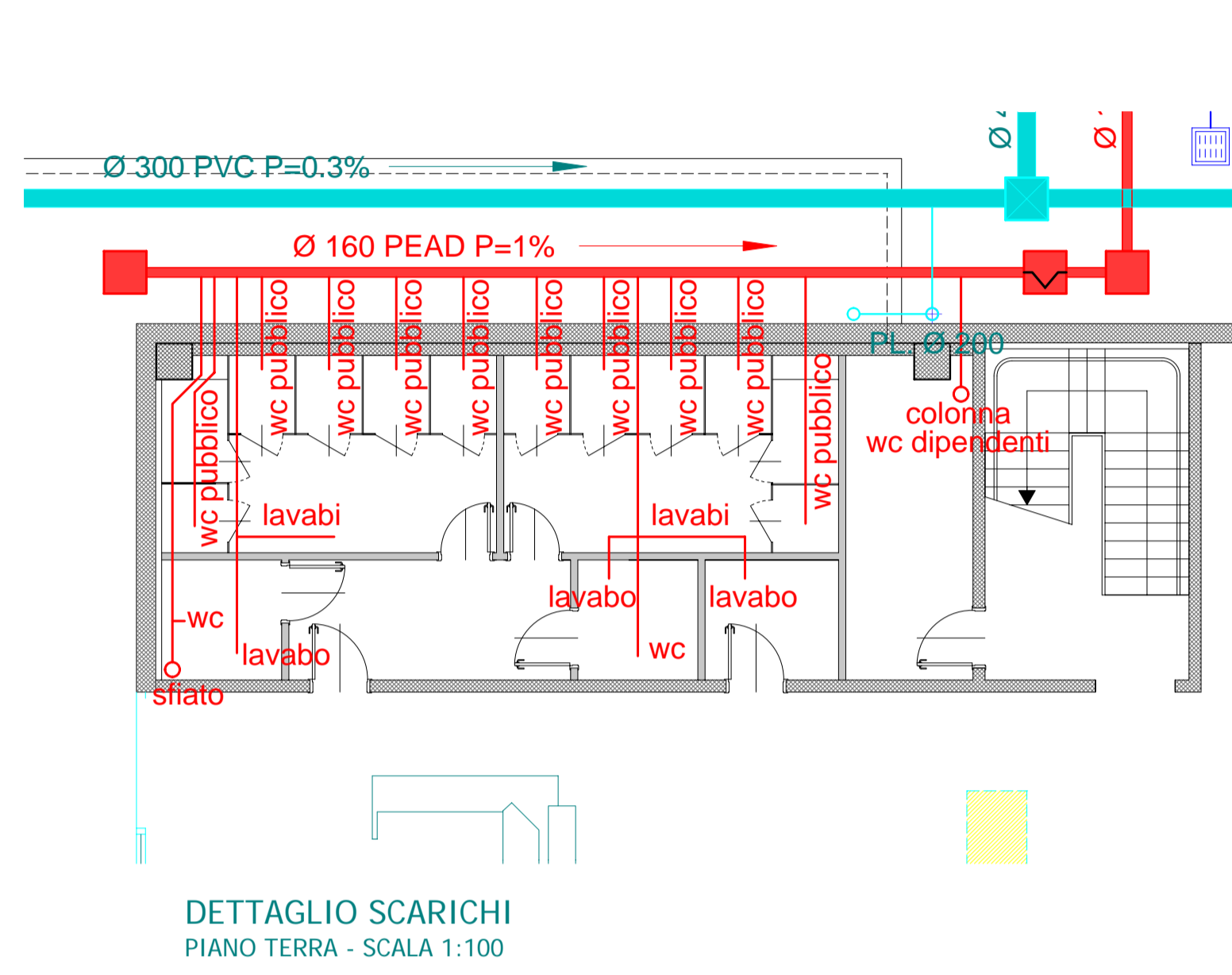
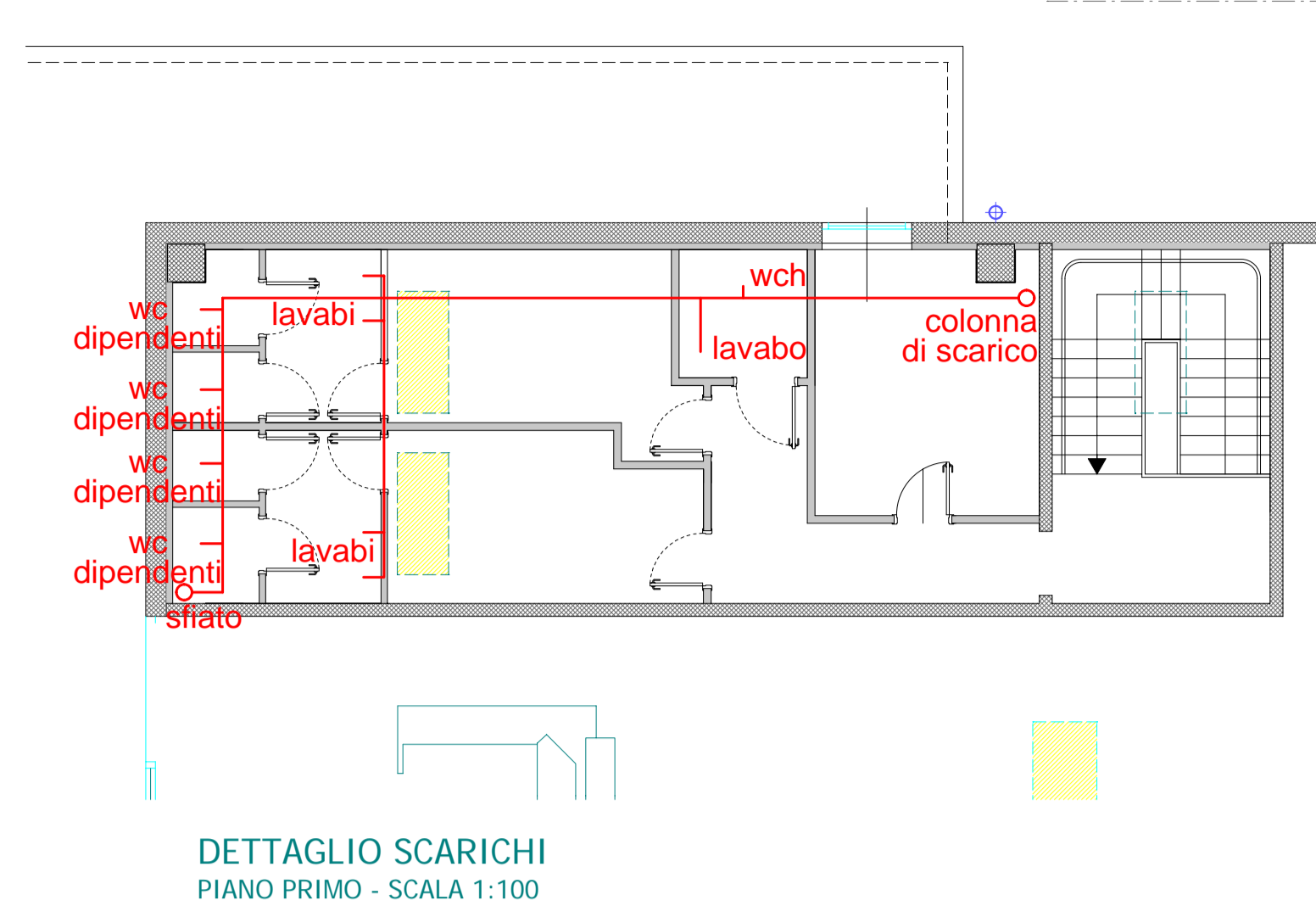
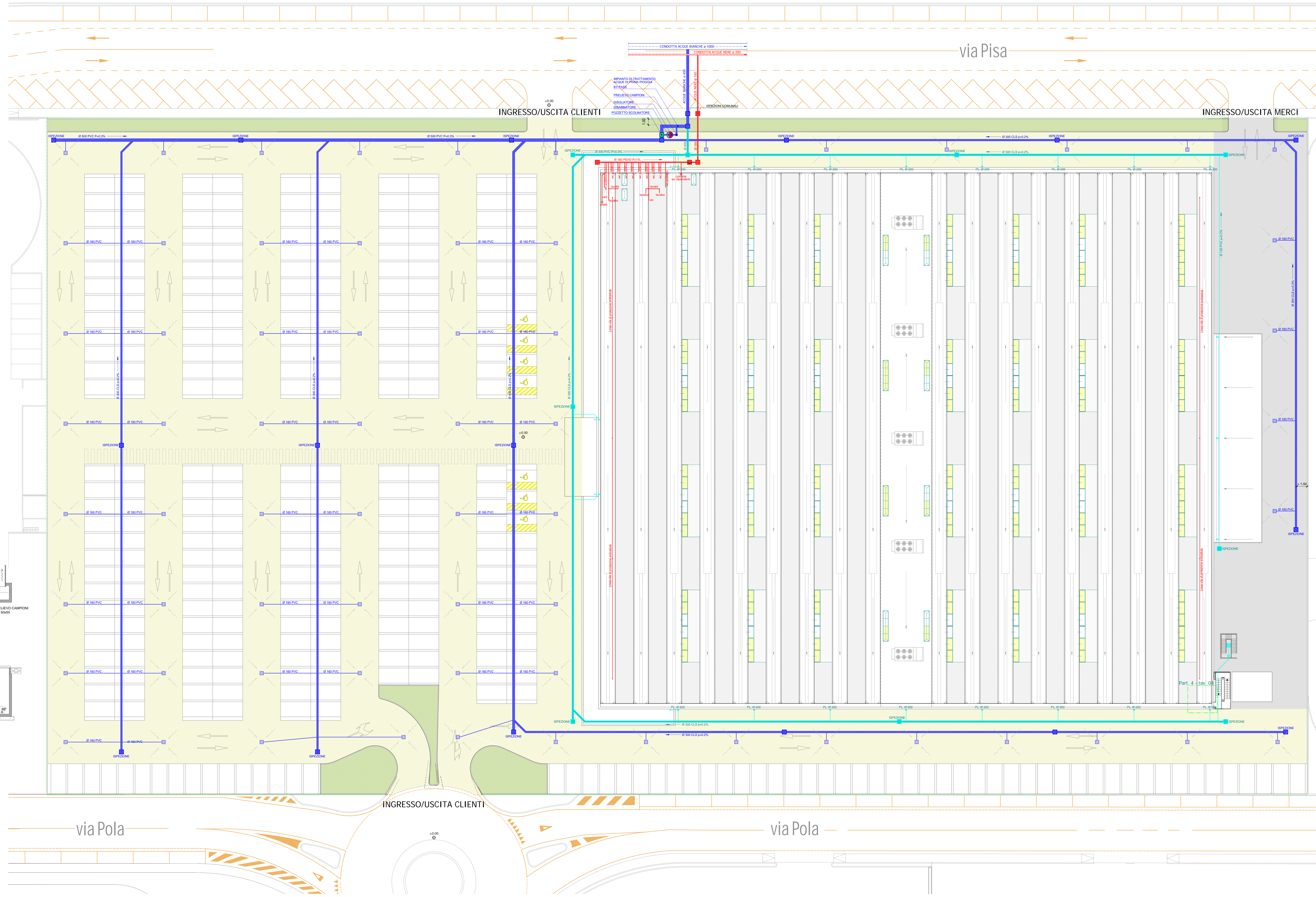
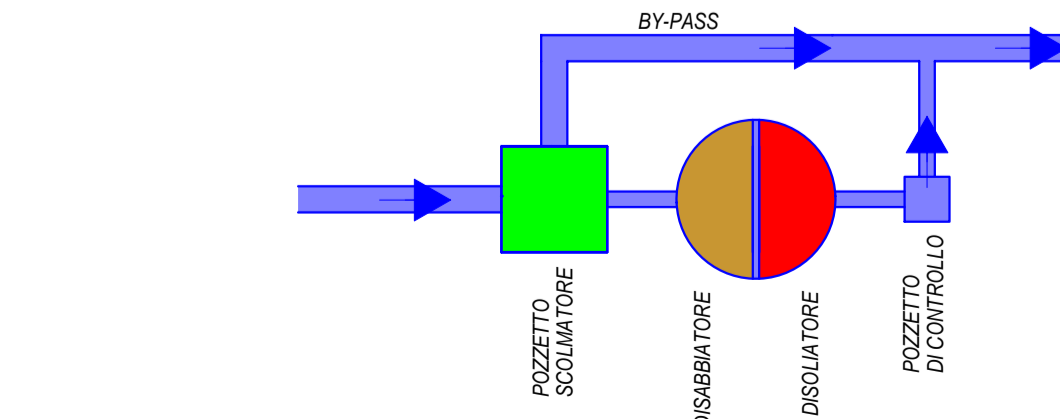

REGIONE DEL VENETO PROVINCIA DI VICENZA COMUNE DI TORRI DI QUARTESOLO

VALUTAZIONE IMPATTO AMBIENTALE EDIFICI A-E PARCO COMMERCIALE "LE PIRAMIDI"

D.Lgs. 3 Aprile 2006 n. 152 e ss.mm.ii.
Legge Regionale del Veneto 18 Febbraio 2016 n. 4

ELABORATI PROGETTUALI EDIFICIO "A"

OGGETTO: PIANTE COPERTURA E SCARICHI TITOLO: 03

PROFONORE: Iniziative Industriali S.p.A. PROGETTISTA: Arch. Gaetano Ingui REDATTORE: Elena Barbato

Via dell'Economia, n. 84 36100 Vicenza (VI) Tel. 0444 297115 Via dell'Economia, n. 90 36100 Vicenza (VI) Tel. 0444 981618 Via dell'Economia, n. 90 36100 Vicenza (VI) Tel. 0444 981618

SCALE: 1:200-1:100 DATA: Dicembre 2016 FILE: 16/03-0652